

# House Wires

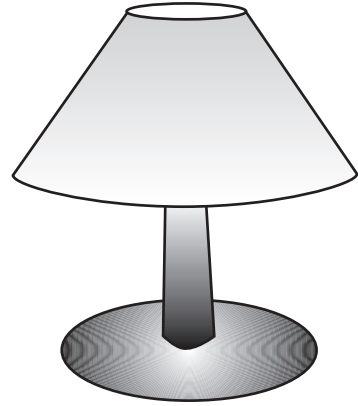

# Light



# Penstock

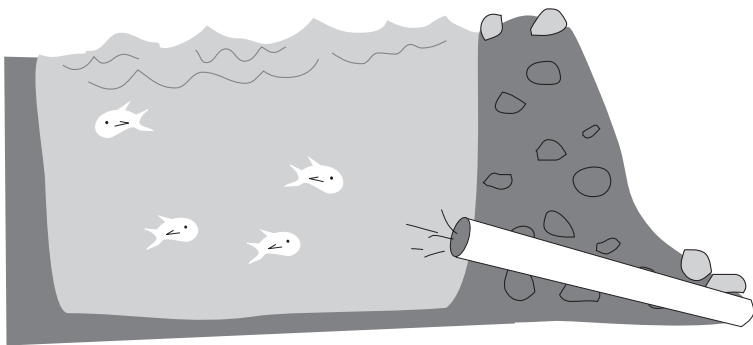

# Snow

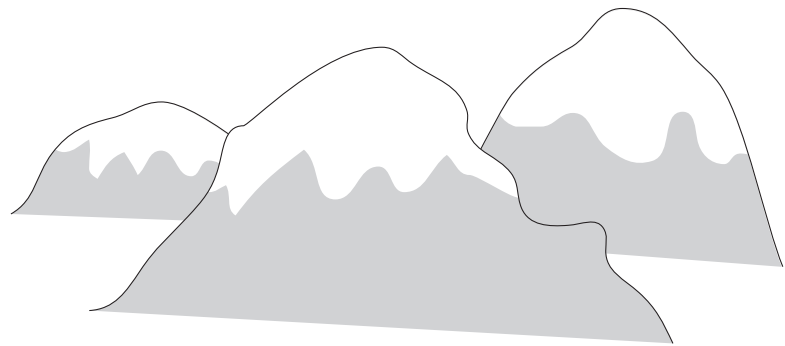

# Rain

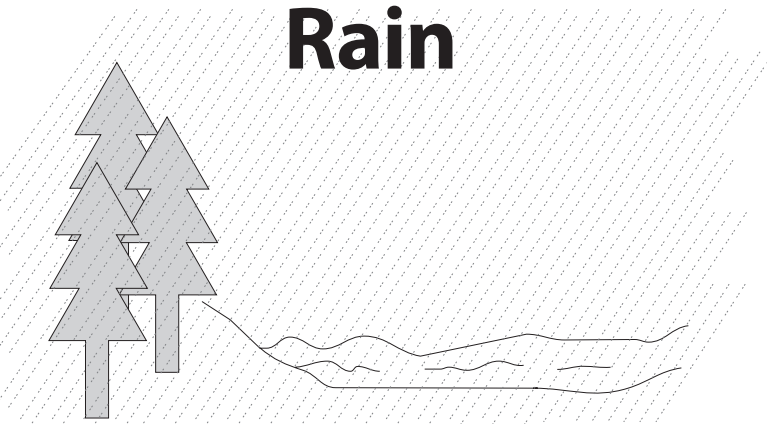

# Turbine

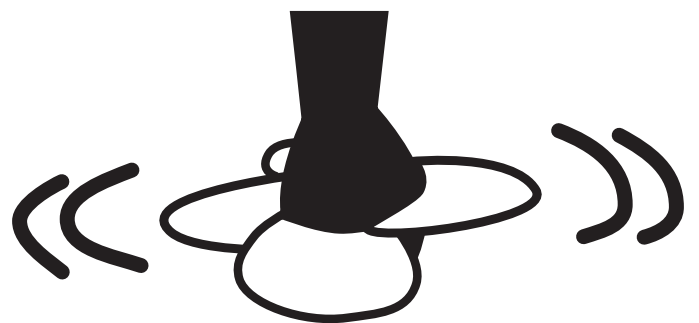

# Transformer

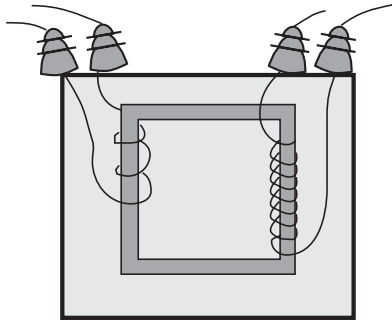

# River

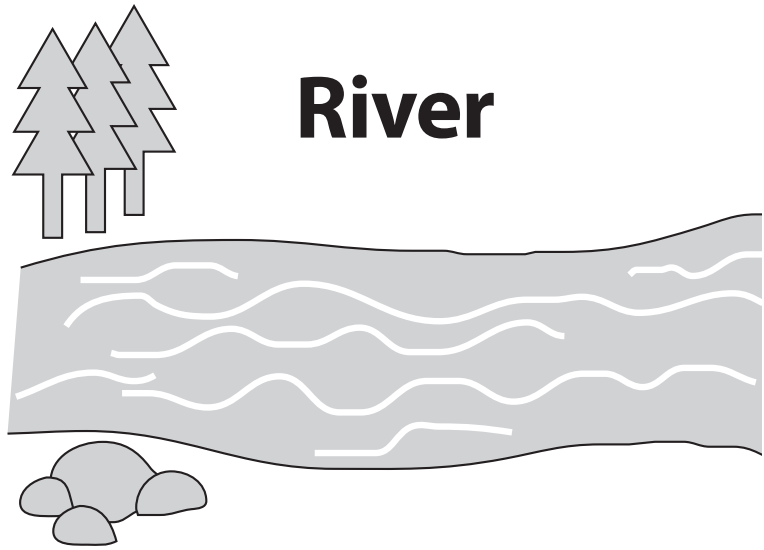

# Distribution Lines

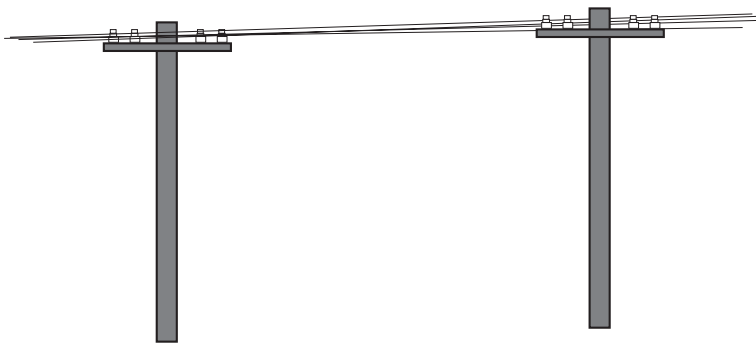

# Shaft

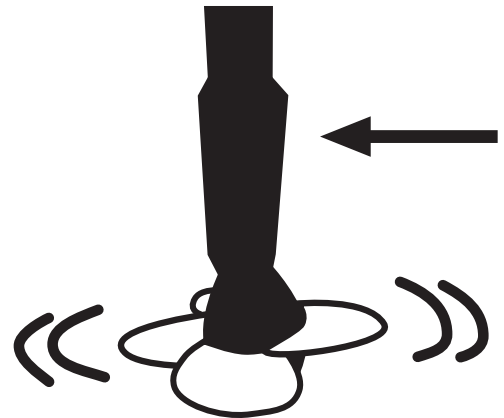

# Substation

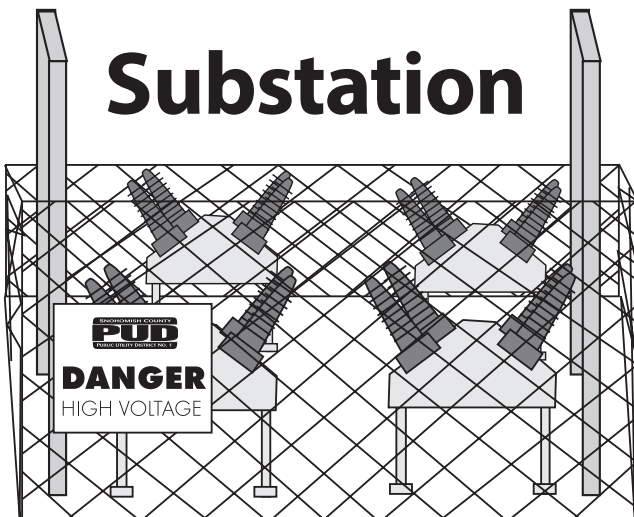

# Reservoir

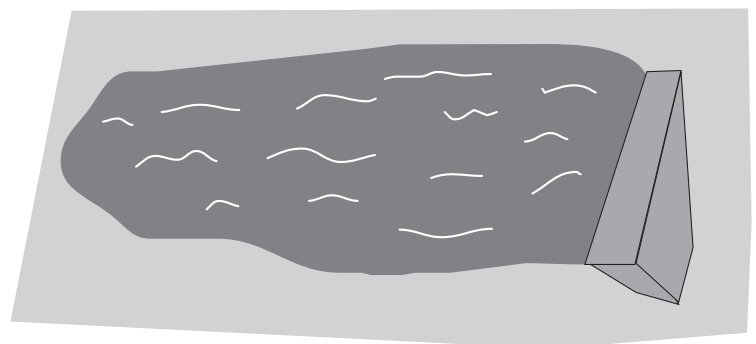

# Dam

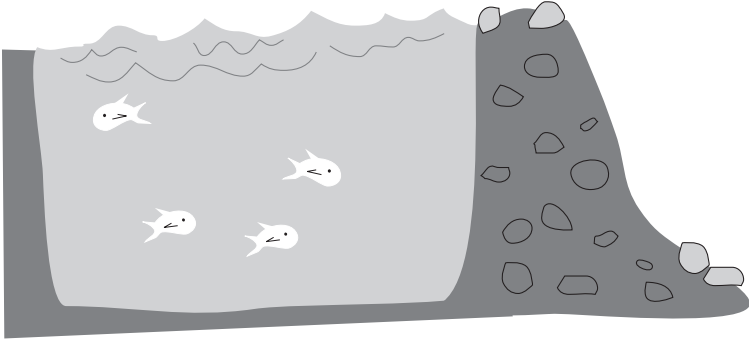

# Pole Transformer

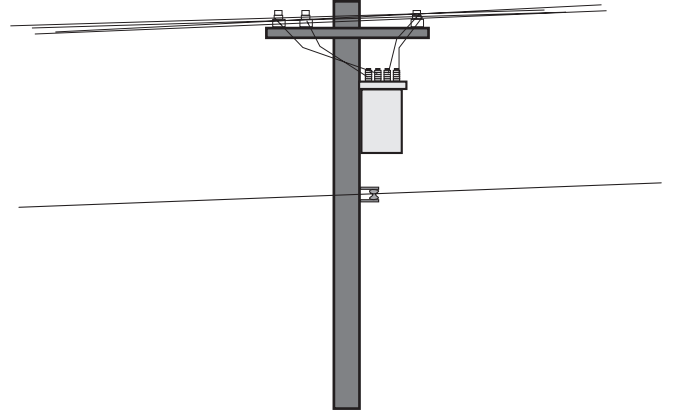

# Generator

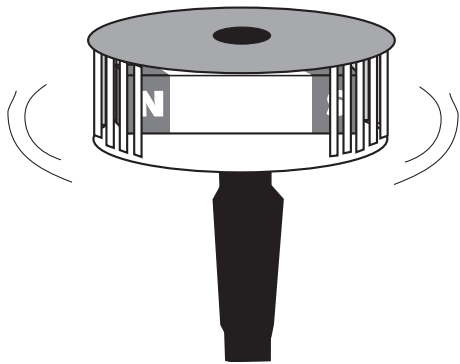

# Transmission Lines

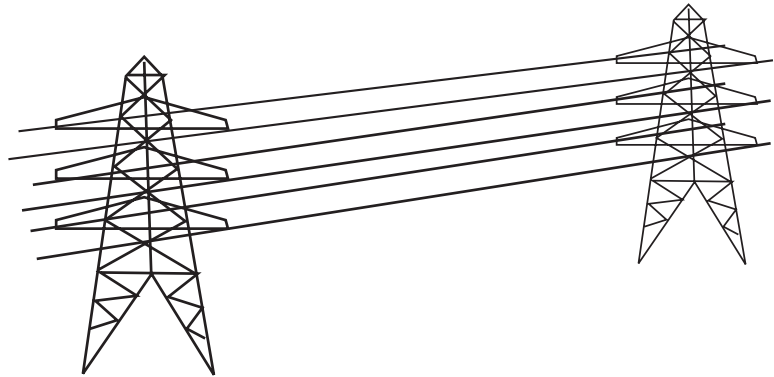

# Outlet

